

Sami[®]

WEARABLE

User Manual WS-2378

GPS PRO SMARTBAND

Thank you for purchasing the **Sami** wearable WS-2378. Read the instructions carefully to obtain optimum results and preserve it for future reference.

DESCRIPTION OF THE WEARABLE.

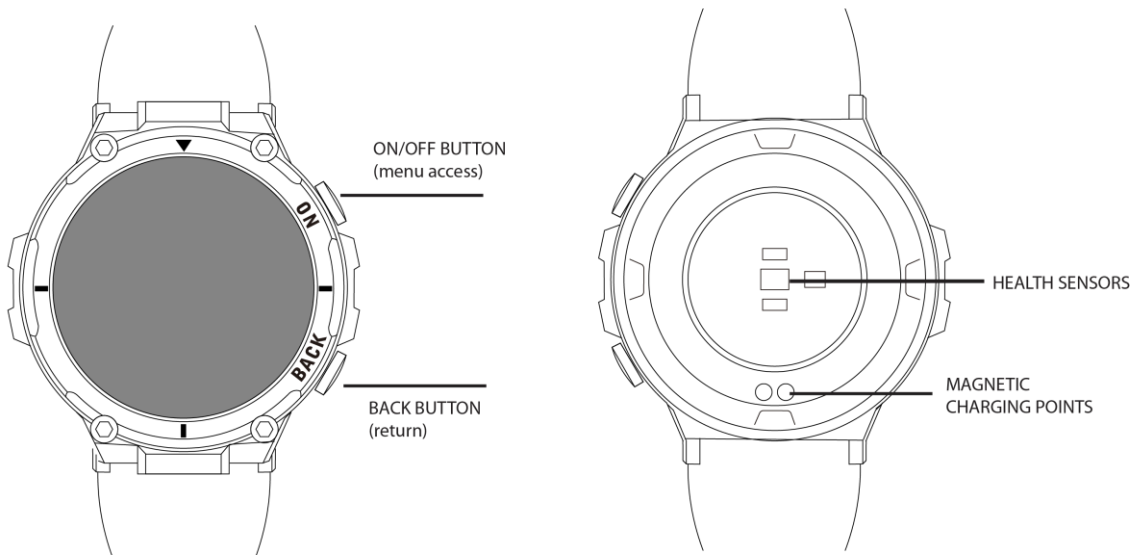

CONTENTS.

Wearable, USB magnetic charging cable, instruction manual.

CHARGING.

Connect the device to a computer or laptop with the USB Magnetic cable for charging. Put in contact the magnetic end of the USB cable with the charging points positioned in the back of your device. Kindly use only the USB cable included with the wearable. If you use a power adapter for charging, the output of the power adapter should be 5V, 1A. Charging time: **1-2** hours approx. Please charge the device fully before using it. Take care with the magnet side of the cable, if you connect to the AC and you have contact with a metal surface, you may damage the charging cable.

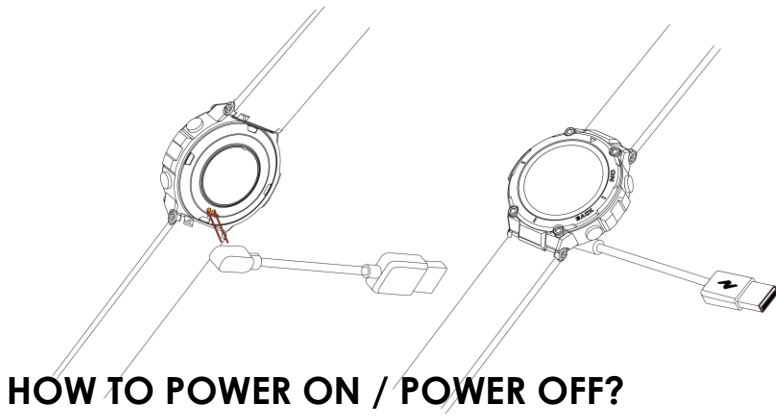

HOW TO POWER ON / POWER OFF?

- 1) To turn ON the smart band, long press the side button ON for a few seconds.
- 2) To turn OFF the smart band, long press the side button ON for a few seconds. Then choose the option of Power off.

HOW TO CONTROL?

This device is equipped with a full touch display screen, it supports full screen touch control.

- 1) In the home page slide the screen as in the following diagram to enter to the different interfaces :

TOUCH SCREEN

Hear Rate, SPo2, Sleep, Weather, Remote Player, Daily Data.

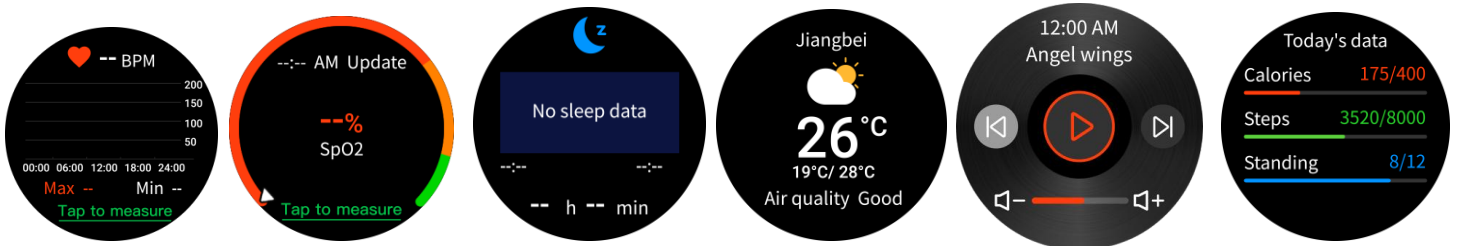

BUTTON PRESS MENÚ ACCESS

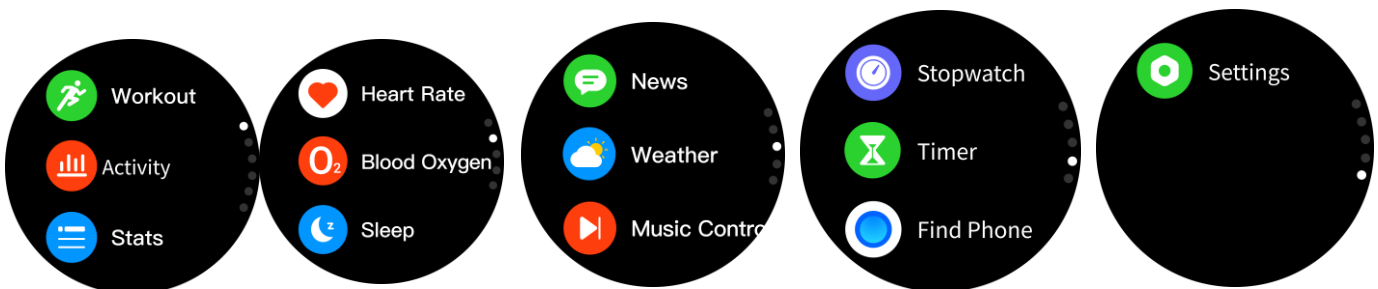

- 1) Short tap in the icon to select/enter in that menu. In the submenus slide from left/right or top/bottom to go to the next/previous page. Short press the side button to return to the previous interface.
- 2) You can download and install more dials on the dial market by the app.

GETTING STARTED:

- For Android

1) How to obtain the BT Connection APK (**Infowear**)

Search for the **Infowear APP** in the Play Store; download it and install it in your Android smartphone, or go to our **website www.sami.es** and download the application.

2) Installation of the **Infowear** APK.

When installing the **Infowear** application on your Android, you must allow all the Application Permissions, allow this **Infowear** app auto run.

The first time you run this **Infowear app**, it will ask you to Enable Notifications, please tap OK and tap the **Infowear** and confirm OK. You must tap OK/Allow/Pair/Yes/Confirm for any pop-up request. On your Android permission management, allow all application permissions.

3) How to make the wearable pair with your Android smart phone?

*First, turn on the Bluetooth of your Phone.

*Second, run the **Infowear** app on your Phone, on the home page of **Infowear**, find the pairing request by the setting all your values requested and then select "**watch**". You must have the screen of the watch on and the APP will search for new Bluetooth device(s), when the available Bluetooth device displays, please select **WS-2378** (the BT name of this device). Select the device on the app to make it pair. Select "**confirm tick**" on the watch and the pairing will be finished in a few seconds. When you pair for the first time, the **Infowear** app will ask you to enable GPS and Bluetooth, and authorize **Infowear** to get access to the location service while using the app. Please accept all the requests for the correct functioning of the device. When you finish select OK/Confirm/Allow for any pop-up request.

4) In the case that on the watch you have the QR CODE on the screen, then in the APP **Infowear** click the icon of scan on the top left of the menu and scan the qr code of the watch with the camera.

Important: To enable all notifications of different softwares such as WhatsApp, Facebook, Skype, Twitter, you will need to turn on the notifications on the APP manually. On the **VeryFit** homepage, select the icon "**Device**" (situated on the right bottom of the screen), → select "**WS-2378**" → select "**message notification**" → turn on "**Allow notification**" and turn on all the APP notifications you want to active. To confirm you must click on the icon ✓

- For iPhone

1) How to obtain the BT Connection APP (**VeryFit**)

Search for the **Infowear APP** in the APP Store; download it and install it in your iOS smartphone

2) Installation of the **Infowear t** APP.

When installing the **Infowear** application on your iOS, you must allow all the Application Permissions, allow this **Infowear** app auto run.

The first time you run this **Infowear app**, it will ask you to Enable Notifications, please tap OK and tap the **Infowear** and confirm OK. You must tap OK/Allow/Pair/Yes/Confirm for any pop-up request. On your Android permission management, allow all application permissions ✓

3) How to make the wearable pair with your Android smart phone?

*First, turn on the Bluetooth of your Phone.

*Second, run the **Infowear** app on your Phone, on the home page of **Infowear**, find the pairing request by the setting all your values requested and then select **"watch"**. You must have the screen of the watch on and the APP will search for new Bluetooth device(s), when the available Bluetooth device displays, please select **WS-2378** (the BT name of this device). Select the device on the app to make it pair. Select **"confirm tick" on the watch** and the pairing will be finished in a few seconds. When you pair for the first time, the **Infowear** app will ask you to enable GPS and Bluetooth, and authorize **Infowear** to get access to the location service while using the app. Please accept all the requests for the correct functioning of the device. When you finish select OK/Confirm/Allow for any pop-up request.

4) In the case that on the watch you have the QR CODE on the screen, then in the APP VeryFit click the icon of scan on the top left of the menu and scan the qr code of the watch with the camera.

* Now you can start using your desired functions of the smart band.

Important: To enable all notifications of different softwares such as WhatsApp, Facebook, Skype, Twitter, you will need to turn on the notifications on the APP manually. On the **Infowear** homepage, select the icon **"Device"** (situated on the right bottom of the screen), → select **"Infowear"** → select **"message notification"** → turn on **"Allow notification"** and turn on all the APP notifications you want to active. To confirm you must click on the icon ✓ located on the top right

PRODUCT FEATURES

BLUETOOTH (BLE 5.0)

TOUCH SCREEN. TFT LCD 1.32" full touch screen

BUILT IN VIBRATING MOTOR

BUILT IN HEART RATE SENSOR

BUILT IN GRAVITY SENSOR

GESTURE CONTROL TO LIGHT UP THE DISPLAY SCREEN

ALLUMINIUM MIDDLE FRAME

WATER PROOF 5 ATM

BUILT IN GPS

1) Time/Date/Battery displaying

2) Several Sports as –Outdoor running / Treadmill / Outdoor cycling / Cycling / Walking / Skating / Freestyle / Basketball / Cricket / Badminton / Tennis / Trail Run / Trekking / Volleyball / Rope Skipping / Climbing Machine / Yoga / Baseball.

Enter to the sports mode by selecting the sports icon, → select the sport type → enter the sports countdown automatically.

During sports, to pause sports short press any side button, and to restore sports short press the side button again. To end up sports long press any side button and then confirm end.

This watch has a built in GPS which can track your activity on outdoor sports.



3) Exercise record

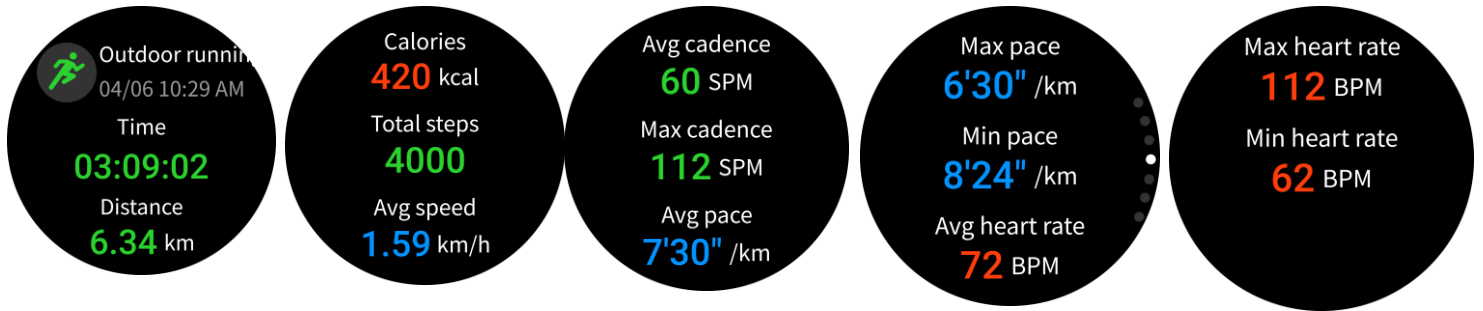

4) Heart Rate

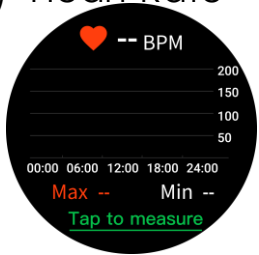

5) Alert High Heart Rate



6) Blood oxygen



7) Sleep

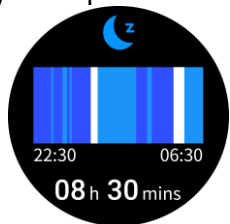

8) Weather forecast



9) Music control – control music via bt on your mobile. Watch cannot playback or store music



10) Stopwatch

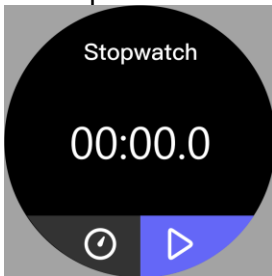

11) Timer

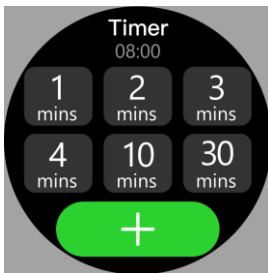

12) Find phone

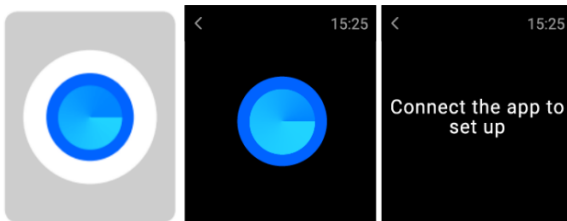

13) Alarm Clock

Up to 5 Alarm Clocks, manage through app.

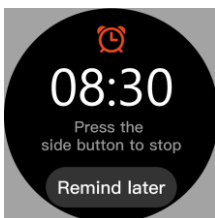

14) Settings: Built in watches faces/Brightness/Vibration/Raise to wake dial/System Settings (Restart/Power Off/Reset)/ APP Qr Code/ About (info of device)

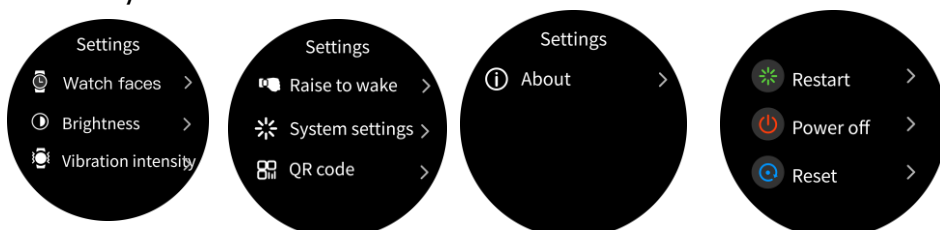

Data can be sync from the wearable to the smart phone on the **Infowear** APK/APP.

Your smart phone will synchronize when the Bluetooth is paired with this device.

FUNCTIONS

PHONE CALL NOTIFICATION - vibrating reminder for incoming phone calls and display on screen. This function needs to be turned on manually at the **Infowear** APK/APP.

MESSAGE NOTIFICATION - vibrating reminder for incoming messages and display on screen, including SMS, WhatsApp, Facebook, Twitter, Skype messages, etc. This function needs to be turned on manually at the **Infowear** APK/APP. Memory for 10 messages.

CLOCK SCREENS (Different home digital clocks) - In the home screen of the smart band, long press the screen for a few seconds to change the style of the digital clock. You can also select the cloud dials from the APK/APP

SLEEP MONITOR - supported on the watch and **Infowear** APK/APP

ALARM CLOCK - supported on the watch and **Infowear** APK/APP

FIND THE DEVICE (Looking for your mobile phone) supported on the **Infowear** APK/APP

SEDENTARY REMIDER (REMINDE TO MOVE) –set it on the **Infowear** APK/APP

Do Not Disturb Mode – set it on the **Infowear** APK/APP

GESTURE CONTROL (Raise your hand to light up the screen).

IN BUILT GPS: view it on the BT APP/APK **Infowear** when you do your sports. When in new location, the GPS will calibrate automatically.

TECHNICAL SPECIFICATIONS:

Display screen: TFT LCD screen 1.32". Full colour touch screen

Screen resolution: 360*360

Internal Memory: 128kb

MCU: Dialog 14695

Touch Sensor: G+F

Accleration and gyroscopes: ST LIS2DW12

GPS: BCM47755

Heart rate sensor: HX3690

Charge I/O port : USB magnetic charging cable

Battery: Built in Li-Polymer 480mAh

Stand by time: 30-40 days

Working time: 7-10 days

Bluetooth: 5.0

Water-resist Rating: 5ATM this device resists 50 meters waterproof (5ATM). Not valid for hot water shower due to vapor.

Weight: 62g

Declaration of Conformity

Hereby we,

Name of manufacturer: SANTOSHI SL
Address: CALLE FELIPE ASENJO N.56
Zip code & City: 28947 - FUENLABRADA (MADRID)
Country: SPAIN

declare that this DoC is issued under our sole responsibility and that this product:

Product description: Smart Band
Type designation(s): WS-2378
Trademark: SAMI WEARABLE

is in conformity with the relevant Union harmonization legislation:

DIRECTIVE EMC 2014/30/EU

DIRECTIVE LVD 2014/35/EU

Standard CE (RED): DIRECTIVE 2014/53/EU

Standard RoHS: 2011/65/EU: (RoHS) Restriction of Hazardous Substance.

with reference to the following standards applied:

EN 60950-1: 2006+A11:2009+A1:2010+A12:2011+A2:2013

EN 62479:2010

EN 301 489-1 V2.1.1 (2017-02)

EN 301 489-17 V3.1.1 (2017-02)

EN 300 328 V2.1.1 (2016-11)



Signature

Full name: VISHAL MIRPURI

Position: ADMINISTRATOR

Date: 10/05/2023